



CD35 PRISMA COMPACT DISC PLAYER

User Guide



CAUTION

TO REDUCE THE RISK OF FIRE, REPLACE WITH THE SAME TYPE AND RATING OF FUSE.

ATTENTION

UTILISER UN FUSIBLE DE RECHANGE MÊME TYPE.

Safety compliance

This product has been designed to meet the IEC 60065 international electrical safety standard.

CAUTION

RISK OF ELECTRIC SHOCK DO NOT OPEN

ATTENTION

RISQUE DE CHOC ELECTRIQUE NE PAS OUVRIR



The lightning flash with an arrowhead symbol within an equilateral triangle, is intended to alert the user to the presence of uninsulated 'dangerous voltage' within the product's enclosure that may be of sufficient magnitude to constitute a risk of electric shock to persons.



The exclamation point within an equilateral triangle is intended to alert the user to the presence of important operating and maintenance (servicing) instructions in the literature accompanying the product.

CAUTION: To reduce the risk of electrical shock do not remove cover (or back). No user serviceable parts inside. Refer servicing to qualified service personnel.

WARNING: To reduce the risk of fire or electrical shock, do not expose this apparatus to rain or moisture.

CAUTION: In Canada and the USA, to prevent electric shock, match the wide blade of the plug to the wide slot in the socket and insert the plug fully into the socket.

This product is designed and manufactured to meet strict quality and safety standards. However, you should be aware of the following installation and operation precautions.

1. Take heed of warnings & instructions

You should read all the safety and operating instructions before operating this appliance. Retain this handbook for future reference and adhere to all warnings in the handbook or on the appliance.

2. Water and moisture

The presence of electricity near water can be dangerous.

Do not use the appliance near water – for example next to a bathtub, washbowl, kitchen sink, in a wet basement or near a swimming pool, etc.

3. Object or liquid entry

Take care that objects do not fall and liquids are not spilled into the enclosure through any openings. Liquid-filled objects such as vases should not be placed on the equipment.

4. Ventilation

Do not place the equipment on a bed, sofa, rug or similar soft surface, or in an enclosed bookcase or cabinet, since ventilation may be impeded. We recommend a minimum distance of 50mm around the sides and top of the appliance to provide adequate ventilation.

5. Heat

Locate the appliance away from naked flames or heat producing equipment such as radiators, stoves or other appliances (including other amplifiers) that produce heat.

6. Climate

The appliance has been designed for use in moderate climates.

7. Racks and stands

Only use a rack or stand that is recommended for use with audio equipment. If the equipment is on a portable rack it should be moved with great care, to avoid overturning the combination.

8. Cleaning

Unplug the unit from the mains supply before cleaning.

The case should normally only require a wipe with a soft, damp, lint-free cloth. Do not use paint thinners or other chemical solvents for cleaning.

We do not advise the use of furniture cleaning sprays or polishes as they can cause indelible white marks if the unit is subsequently wiped with a damp cloth.

9. Power sources

This appliance must be connected to a mains socket outlet using the supplied power cord. To disconnect this apparatus from power, you must disconnect the power cord. Make sure the power cord is always easily accessible.

Only connect the appliance to a power supply of the type

described in the operating instructions or as marked on the appliance.

This is a Class 1 device and **must** be earthed.

The power switch is a single-pole switch. When the switch is in the "Off" position, the appliance is not completely disconnected from the main power.

10. Power-cord protection

Power supply cords should be routed so that they are not likely to be walked on or pinched by items placed upon or against them, paying particular attention to cords and plugs, and the point where they exit from the appliance.

11. Grounding

Ensure that the grounding means of the appliance is not defeated.

12. Power lines

Locate any outdoor antenna/aerial away from power lines.

13. Non-use periods

If the unit has a stand-by function, a small amount of current will continue to flow into the equipment in this mode. Unplug the power cord of the appliance from the outlet if left unused for a long period of time.

14. Abnormal smell

If an abnormal smell or smoke is detected from the appliance, turn the power off immediately and unplug the unit from the wall outlet. Contact your dealer immediately.

15. Servicing

You should not attempt to service the appliance beyond that described in this handbook. All other servicing should be referred to qualified service personnel.

16. Damage requiring service

The appliance should be serviced by qualified service personnel when:

- A. the power-supply cord or the plug has been damaged, or
- B. objects have fallen, or liquid has spilled into the appliance, or
- C. the appliance has been exposed to rain, or
- D. the appliance does not appear to operate normally or exhibits a marked change in performance, or
- E. the appliance has been dropped or the enclosure damaged.

2.4G and 5G FCC Statements

This device complies with Part 15 of the FCC Rules. Operation is subject to the following two conditions:

1. This device may not cause harmful interference, and
2. This device must accept any interference received, including interference that may cause undesired operation.

Cet appareil est conforme à la section 15 des réglementations de la FCC. Le fonctionnement de l'appareil est sujet aux deux conditions suivantes :

1. cet appareil ne doit pas provoquer d'interférences néfastes, et
2. cet appareil doit tolérer les interférences reçues, y compris celles qui risquent de provoquer un fonctionnement indésirable.

Note: This product has been tested and found to comply with the limits for a Class B digital device, pursuant to Part 15 of the FCC Rules. These limits are designed to provide reasonable protection against harmful interference in a residential installation. This product generates, uses, and can radiate radio frequency energy and, if not installed and used in accordance with the instructions, may cause harmful interference to radio communications. However, there is no guarantee that interference will not occur in a particular installation. If this product does cause harmful interference to radio or television reception, which can be determined by turning the equipment off and on, the user is encouraged to try to correct the interference by one or more of the following measures:

- Reorient or relocate the receiving antenna.
- Increase the separation between the equipment and receiver.
- Connect the equipment into an outlet on a circuit different from that to which the receiver is connected.
- Consult the dealer or an experienced radio/TV technician for help.

Please take attention that changes or modification not expressly approved by the party responsible for compliance could void the user's authority to operate the equipment.

This equipment should be installed and operated with a minimum distance 20cm between the radiator and your body.

Cet équipement doit être installé et utilisé à une distance minimale de 20 cm entre le radiateur et votre corps.

This device complies with Industry Canada licence-exempt RSS standard(s). Operation is subject to the following two conditions:

1. this device may not cause interference, and
2. this device must accept any interference, including interference that may cause undesired operation of the device.

Le présent appareil est conforme aux CNR d'Industrie Canada applicables aux appareils radioexempts de licence. L'exploitation est autorisée aux deux conditions suivantes :

1. l'appareil ne doit pas produire de brouillage, et
2. l'utilisateur de l'appareil doit accepter tout brouillage radioélectrique subi, même si le brouillage est susceptible d'en compromettre le fonctionnement.

Under Industry Canada regulations, this radio transmitter may only operate using an antenna of a type and maximum (or lesser) gain approved for the transmitter by Industry Canada. To reduce potential radio interference to other users, the antenna type and its gain should be so chosen that the equivalent isotropically radiated power (e.i.r.p.) is not more than that necessary for successful communication.

Conformément à la réglementation d'Industrie Canada, le présent émetteur radio peut fonctionner avec une antenne d'un type et d'un gain maximal (ou inférieur) approuvé pour l'émetteur par Industrie Canada. Dans le but de réduire les risques de brouillage radioélectrique à l'intention des autres utilisateurs, il faut choisir le type d'antenne et son gain de sorte que la puissance isotrope rayonnée équivalente (p.i.r.e.) ne dépasse pas l'intensité nécessaire à l'établissement d'une communication satisfaisante.



The CE symbol indicates that this Primare product complies with the EMC (Electromagnetic Compatibility) and LVD (Low Voltage Directive) standards of the European Community.

The WEEE symbol indicates this Primare product complies with the European Parliament and Council Directive 2002/96/EC concerning Waste Electrical and Electronic Equipment (WEEE). This product must be appropriately recycled or processed in accordance with these directives. Consult your local waste disposal authority for guidance.

The RoHS symbol indicates that Primare products are designed and manufactured to comply with the Restriction of Hazardous Substances (RoHS) as stated in the European Parliament and Council Directive 2002/95/EC.

Copyright and acknowledgments

Copyright © 2017-18 Primare AB.

All rights reserved.

Primare AB
Limstensgatan 7
21616 Limhamn
Sweden

<http://www.primare.net>

Issue: CD35Prisma/2

The information in this guide is believed to be correct as of the date of publication. However, our policy is one of continuous development and so the information is subject to change without notice, and does not represent a commitment on the part of Primare AB.

Primare is a trademark of Primare AB.

This guide was produced by
Human-Computer Interface Ltd.
<http://www.interface.co.uk>

CONTENTS

WELCOME!

Getting Started

- 1 Unpack the CD35
- 2 Connect to an amplifier
- 3 Connect the antennae
- 4 Connect a USB flash drive
- 5 Connect power
- 6 Connect to a network
- 8 Play a CD

Back-panel connections

Using the remote control

- Selecting CD35 mode
- Fitting the batteries

Using the CD35

- Front panel controls
- Playing a disc
- Locating a position on the disc

Advanced features

- Changing the front panel display
- Playing a specific track
- Repeat playback

Playing music from a drive or music server

Streaming music from a phone, tablet, or PC

6	Configuring the settings	15
7	Using the settings menus	15
7	PLAYBACK SETTINGS	15
7	AUDIO SETTINGS	15
7	GENERAL SETTINGS	16
7	STREAMING SETTINGS	16
7	NETWORK SETTINGS	16
8	Technical specification	17
8	Features	17
9	Outputs	17
9	Performance	17
10	Network	17
10	General	17
10	Additional information	18
11	Phase	18
11	Burn-in	18
11	RS232 and trigger	18
11	Using the CD35 with an I35	18
12	Factory reset	18
12	Network troubleshooting	18
12	Spotify Connect	18
12	Index	19
13		
14		

WELCOME!

Congratulations on selecting your new CD35 Prisma Compact Disc Player

This user guide describes the features and explains how to set up the compact disc player for the best sound quality and ease of operation in order to allow for the most enjoyable reproduction of sound from all your sources.

For additional support and assistance please contact your local authorized Primare dealer, or visit our website at www.primare.net.



GETTING STARTED

1 Unpack the CD35

Your CD35 is supplied with:

- This User Guide
- The Chromecast built-in Quick Start Guide
- Mains cable
- IR cable
- Trigger cable
- Antennae for Bluetooth and Wi-Fi
- C25 remote control with batteries
- AC Polarity Pen

If any of these items are missing please contact your supplier. We recommend you retain the packaging in case you need to transport the unit at a later date.

Note that the CD35 is supplied with a protective film on the display glass. Remove the film for a clearer whiter display.

2 Connect to an amplifier

Analogue outputs

The analogue output provides for both the recommended balanced XLR outputs and the conventional unbalanced RCA outputs for connecting to an appropriate stereo amplifier or preamplifier.

- Connect the appropriate outputs to your amplifier or preamplifier using a suitable cable.

Digital outputs

Alternatively the CD35 Compact Disc Player provides one coax digital output and one optical digital output for connection to a digital preamplifier or digital surround processor.

- Connect the appropriate output to your preamplifier or surround processor using a suitable cable.

3 Connect the antennae

- Connect the two antennae supplied with the CD35 to the ANT 1 and ANT 2 sockets on the back panel, and position the two antennae at a slight angle from the vertical.

One antenna is for Bluetooth connectivity, and the other one is for Wi-Fi connectivity.

4 Connect a USB flash drive

You can optionally connect a USB flash drive or USB hard drive to the USB-A input to play audio files from the drive. For more information see *PLAYING MUSIC FROM A DRIVE OR MUSIC SERVER*, page 13.

5 Connect power

- Plug one end of the mains cable supplied with the CD35 into the power connector on the back panel, and connect the other end to a wall socket.

If this cable is not suitable for your power outlets please contact your supplier for an alternative cable.

Note: See *Phase*, page 18, for information about getting the best sound from your CD35.



WARNING: Always disconnect the CD35 from the mains power before connecting or disconnecting any cables.

- Switch on the CD35, using the switch on the back panel.

To switch on from standby

- Press the  button on the front panel or remote control.

The display shows:

PRIMARE

6 Connect to a network

For best results we recommend connecting via cable.

Connecting via an Ethernet cable

- Connect an Ethernet cable between your router and the LAN socket on the back panel of the CD35.

When the CD35 is ready to set up the network the display will show:

Configure network

- Install the free **Google Home** app on your mobile device.
- Run **Google Home**.

It will display **New device found, CD35**.

- Click **SET UP** and follow the instructions.

After playing a test sound you will be prompted to select a name for your CD35.

You will now be able to stream music to your CD35.

Connecting via Wi-Fi

When the CD35 is ready to set up the network the display will show:

Setup mode

- Make sure Bluetooth and Wi-Fi are enabled on your mobile device.
- Install the free **Google Home** app on your mobile device.
- Run **Google Home**.

It will display **New device found, CD35**.

- Click **SET UP** and follow the instructions.

After playing a test sound you will be prompted to connect to your home Wi-Fi network.

- Select your Wi-Fi network and enter the password.

You will now be able to stream music to your CD35.

8 Play a CD

- Press and hold the **■/▲** button on the front panel or remote control to open the tray.
- Place the CD in the tray with the label facing upwards.
- Press the **▶/▶** button on the front panel, or the **▶||** button on the remote control, to close the tray and start playing the disc.

For more information about playing a CD see *Using the CD35*, page 11.

BACK-PANEL CONNECTIONS

The following diagram explains the function of each of the connectors on the back panel:

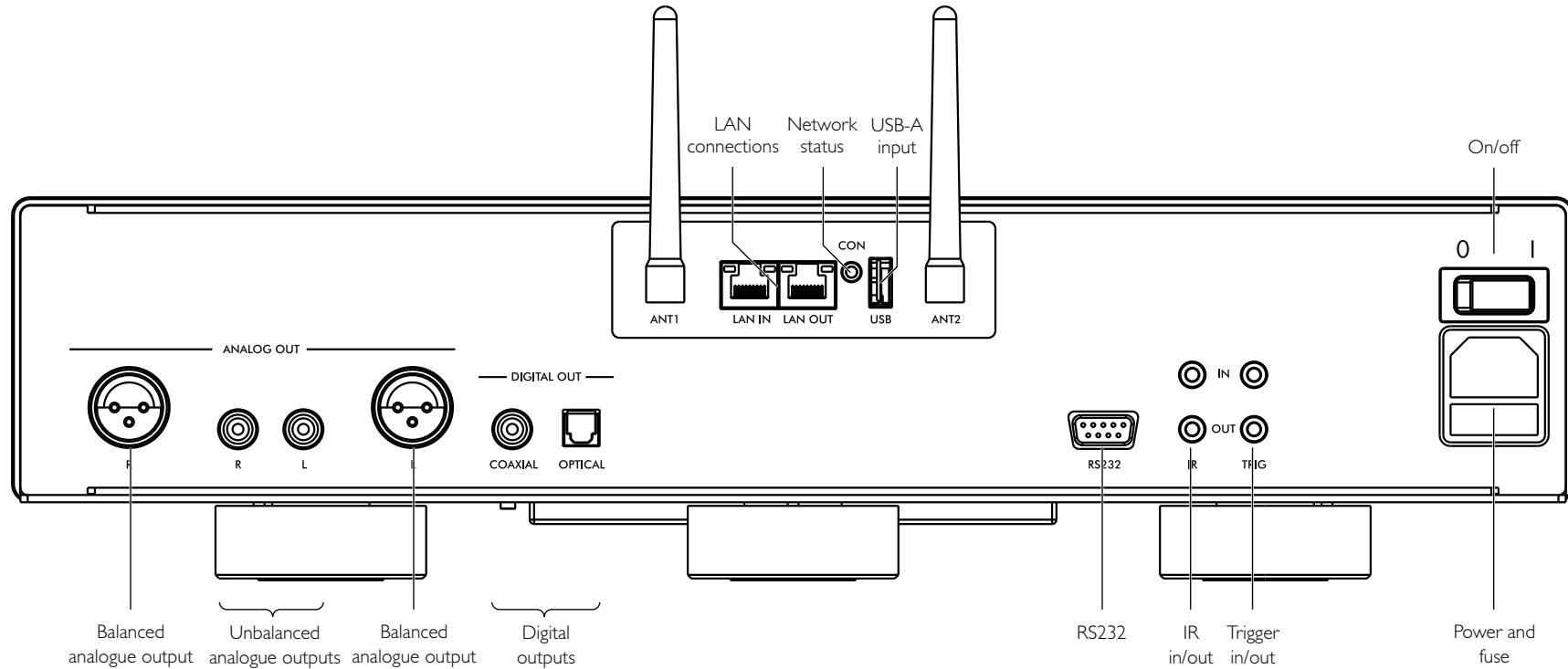

USING THE REMOTE CONTROL

Selecting CD35 mode

The remote control can operate any associated Primare products you have in your system.

To make the remote control operate the CD35

- Press the **CD SC** button once.

To make the remote control operate another product

- Press the **AMP AV**, **CD SC**, or **PRE AUX** button as appropriate.

Press once to select the product on the top line of the button, or twice to select the product on the second line.

The indicators at the top of the remote control light when pressing a button to show which mode the remote control is in.

Fitting the batteries

Before using the remote control you need to insert the two AAA cells supplied with the C25.

- Open the cover on the back of the remote control by pressing the back cover gently near the centre of the remote control, and sliding it towards the edge of the remote control.
- Insert the two batteries, with the polarity as indicated on the bottom of the battery compartment.
- Replace the cover and push until it clips into place.



Note: Replace only with 1.5V alkaline cells type AAA or equivalent.

When disposing of old batteries please be considerate to the environment.

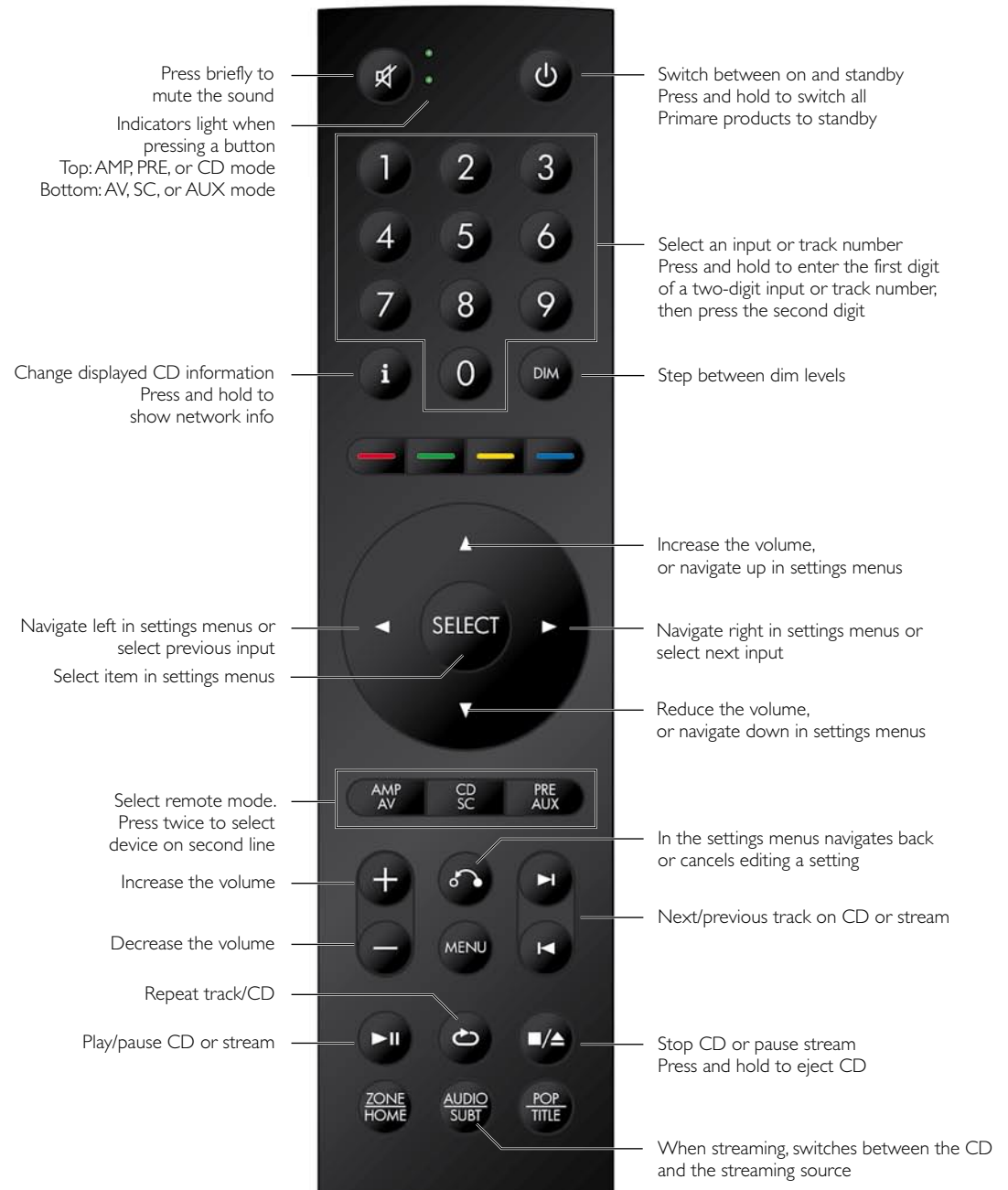

USING THE CD35

Front panel controls

Standby

Switches the CD35 to standby, or switches it on from standby.

Play/Skip

When the disc is stopped: plays the disc.

When the disc is playing: skips to the next track.

Press and hold: skips back through the tracks.

Stop/Open





When the disc is playing: pauses the disc.

When the disc is paused: stops the disc.





When the disc is stopped: opens or closes the CD tray.



Press and hold: opens the CD tray.

Settings menus

Pressing   and   simultaneously displays the settings menus or exits from the menus.

In the settings menus:





Pressing   or   steps between the settings.

Holding down   selects a setting or saves an edited setting.

Holding down   navigates back or cancels editing a setting.

Playing a disc

To insert a disc

- Press and hold the   button on the front panel, or on the remote control, to open the tray.
- Place the CD in the tray with the label facing upwards.
- Press the   button again to close the tray (or press the  button).





The display shows:

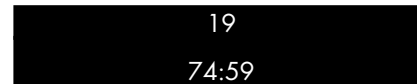

followed by the number of tracks and total time:





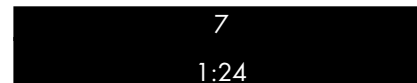

To play the disc

- Press the   button on the front panel, or the   button on the remote control.

While a disc is playing the display shows the current track number and the elapsed time of the current track; for example:





To pause the disc



- Press the   button on the front panel, or the   button on the remote control, while the disc is playing.

The display shows the pause symbol:



You can then resume play by pressing the   button on the front panel or the   button on the remote control.



To stop play

- Press the   button on the front panel or the remote control.



Locating a position on the disc

You can step between tracks to locate a particular track on the disc, or you can scan forwards or backwards to locate a position within a track.

To step forwards through the tracks

- Press the   button on the front panel, or press the  button on the remote control.

To step back through the tracks



- Press and hold the   button on the front panel, or press the  button on the remote control.

The front panel display shows the track number:



- Release the button to start playing the selected track from the beginning.

To scan through the disc

- Hold down the  or  button on the remote control to scan at 4X speed.

The display shows the position within the track.

- Release the  or  button to start playing from the position you have located

ADVANCED FEATURES

Changing the front panel display

You can choose how the time is shown on the front panel display, and change the brightness.

To change the time display

- Press the **i** button.

The display switches between the following four options:

Elapsed time for the current track

A black rectangular display showing the time 3:45 in white text.

Remaining time for the current track

A black rectangular display showing the time -1:15 in white text.

Elapsed time for the entire disc

A black rectangular display showing the time 18:45 with the word 'All' in a smaller font to the right.

Remaining time for the entire disc

A black rectangular display showing the time -41:15 with the word 'All' in a smaller font to the right.

To change the front panel display brightness

- Press the **DIM** button on the remote control to step through the three levels of illumination and blank.

If you turn the display off it will be restored briefly when you operate any control.

The display automatically dims after ten minutes; you can adjust this delay in the settings menus; see *GENERAL SETTINGS*, page 16.

Playing a specific track

You can play from any track by entering the track number on the remote control.

To play from a specific track

- Specify the track number by pressing one of the buttons **1-9**.

To enter a two-digit track number press and hold down the button corresponding to the first digit, and then press the second digit.

To enter a three-digit track number press and hold down the 0 button, and then press the three digits.

Repeat playback

You can play the current track repeatedly, or repeat the entire disc.

To repeat the current track

While the disc is playing:

- Press the  button on the remote control.

The front panel shows **RPT**.

To repeat the entire disc

- Press the  button twice.

The front panel shows **RPT ALL**.

To turn off repeat

- Press the  button again.

The **RPT** symbol in the display will be cleared.

PLAYING MUSIC FROM A DRIVE OR MUSIC SERVER

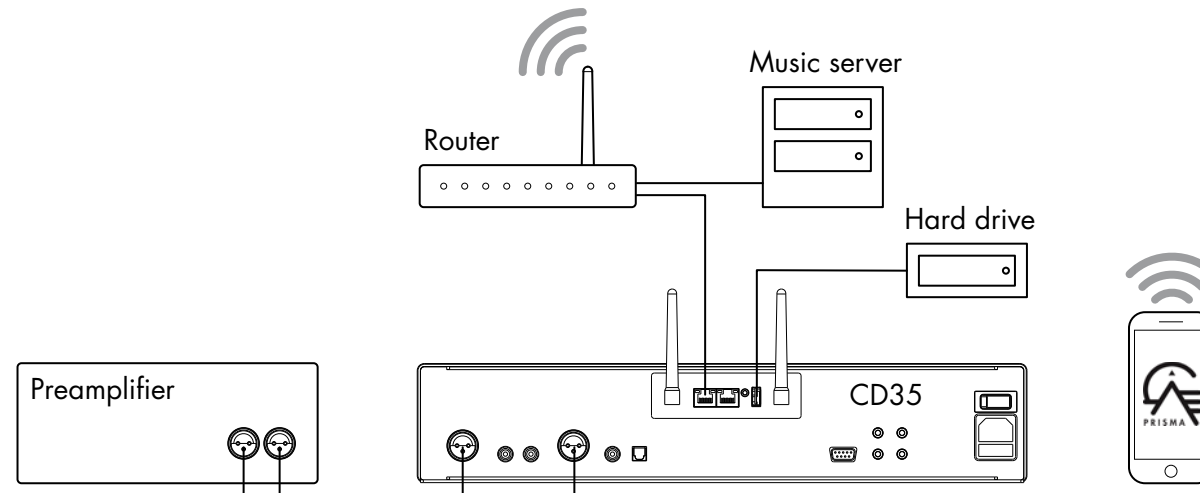

You can play audio files from a USB flash drive, external USB hard disk, or a network drive. These options are ideal if you already have a digital library of CDs or music files.

On a USB flash drive or USB hard disk the files can be organised into folders, giving you one way of classifying your music; eg by Artist.

On a NAS drive you have the option of running a media server program, which will catalogue your music library and give you the option of organising it in different ways; eg by Artist, Genre, Album, or Composer. One free option is MinimServer; see <http://minimserver.com/>.

To play audio files from a USB flash drive or hard drive

- Connect the USB drive to the USB-A input on the CD35.

The USB drive can contain folders and music files in any of the popular formats; see *TECHNICAL SPECIFICATION*, page 17, for details.

- Use the Prisma app to browse, play, and control the music.

To play audio files from a NAS (network) drive

- Connect the NAS drive to the same network as the CD35.

The NAS drive can either contain folders and music files in any of the popular formats, or it can run a music server. See *TECHNICAL SPECIFICATION*, page 17, for details of the supported file formats.

- Use the Prisma app to browse, play, and control the music.

Alternatively you can select and play music from a Mac or PC using a music server program such as JRiver or Foobar2000.

STREAMING MUSIC FROM A PHONE, TABLET, OR PC

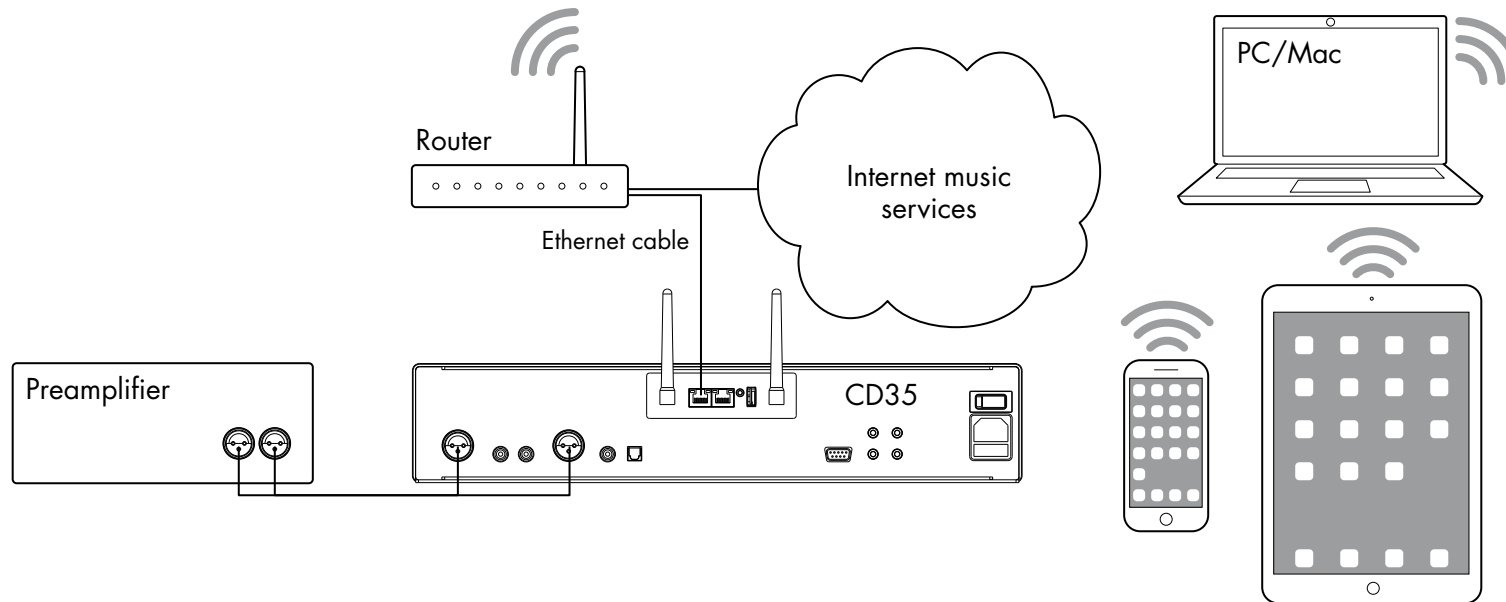

The CD35 can use Chromecast to connect directly to a music service that supports Chromecast, such as Spotify, Deezer, Tidal, or TuneIn Radio. The music is streamed direct to the CD35; once set up you can use your phone to make calls, or play other audio.

With a phone, tablet, or Mac/PC you can also play the audio wirelessly to the CD35, using Bluetooth or AirPlay (iOS only), so the sound from any apps you run on your device will be played through the CD35.

Although you can stream music over Wi-Fi, for best results connect the CD35 to your home router via an Ethernet cable. If necessary, use the Google Home app to configure the network settings on your CD35.

To stream using Chromecast

The CD35 has Chromecast built-in, which means you can stream (cast) music over your network directly to the CD35 from any Chromecast supported music service, using the music service's app on your desktop or mobile device as a controller.

- Click the Cast button within your music service's app and select the CD35 in the device list.

To stream using AirPlay

Use AirPlay to send audio over the network from your Apple device to the CD35. AirPlay is only available on Apple devices.

To stream using Bluetooth

Use Bluetooth to send audio directly to the CD35 from your Bluetooth device using Bluetooth connection. You don't need a network to stream using Bluetooth.

To stream using Spotify Connect

The CD35 supports Spotify Connect, which means you can stream music directly to the CD35 from the Spotify music service over your network, using the Spotify app on your desktop or mobile device as a controller.

Here are Spotify's instructions:

Listen out loud with Spotify Connect

1. Connect the CD35 to your wifi network.
2. Open up the Spotify app on your phone, tablet or laptop using the same wifi network.
3. Play a song and select **Devices Available**.
4. Select the CD35 and start listening.

CONFIGURING THE SETTINGS

Using the settings menus

You can view and change the CD35 settings from the front panel, remote control, or using the Prisma app.

To display the settings menu

- Press ►/▶ and ■/▲ on the front panel simultaneously, or the **MENU** button on the remote control.

The settings menu is displayed:

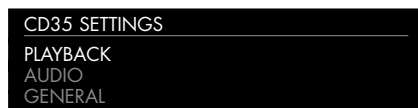

To step between settings

- Press the ►/▶ or ■/▲ buttons on the front panel, or the ▲ or ▼ buttons on the remote control.

The current setting is shown highlighted.

To change a setting

- Press and hold the ►/▶ button on the front panel, or press the **SELECT** button on the remote control.

The current value is shown highlighted.

- Press the ►/▶ or ■/▲ buttons on the front panel, or the ▲ or ▼ buttons on the remote control, to change the value of the setting.

As you change it the new value is shown in the menu.

- Press and hold the ►/▶ button on the front panel, or press the **SELECT** button on the remote control, to save the value you have set.

To navigate back or cancel editing a setting

- Press and hold the ■/▲ button on the front panel, or press the ↶ button on the remote control.

To exit from the settings menu

- Press ►/▶ and ■/▲ on the front panel simultaneously, or press the **MENU** button on the remote control.

PLAYBACK SETTINGS

The **PLAYBACK SETTINGS** menu allows you to customise the auto resume feature:

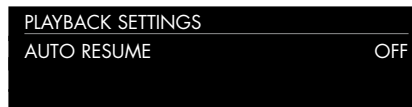

AUTO RESUME

Specifies whether disc playback will start from the previously saved point.

Choose **OFF** to play from the beginning or **ON** to play from the previously saved point.

AUDIO SETTINGS

The **AUDIO SETTINGS** menu allows you to customise the balance and start-up volume, and the maximum and mute volume.

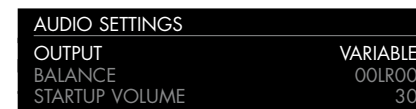

OUTPUT

Specifies whether the output is **VARIABLE** (default) or **FIXED**.

Selecting **FIXED** will show a loud-volume warning. Select **YES** to proceed or **NO** to cancel the fixed gain setting.

If **VARIABLE** is selected the following additional settings are available.

BALANCE

Allows you to adjust the balance between 00LR-9 (far left), 00LR00 (centred, default) and -9LR00 (far right).

STARTUP VOLUME

Sets the general startup volume to between 0 and 60. The default is 30.

MAXIMUM VOLUME

Sets the maximum volume limit between 0 and 99. The default is 99.

MUTE VOLUME

Sets the volume when unit is muted. You can choose between 0 (default) and 30.

If the current volume is lower than the specified **MUTE VOLUME**, the volume will be set to 0 when pressing mute.

GENERAL SETTINGS

The **GENERAL SETTINGS** menu allows you to configure the general operation of the CD35:



FRONT PANEL

Choose **LOCKED** to lock the front panel buttons and knobs, or **UNLOCKED** (default) to use them.

To unlock the front panel buttons use the remote control to select this menu, or remove power from the CD35 for a few seconds.

AUTO-DIM

Allows you to choose the delay for dimming the display after no user interaction, between: **AFTER 1MIN**, **AFTER 5MIN**, **AFTER 10MIN** (default), or **OFF**.

LED BRIGHTNESS

Displays the **LED BRIGHTNESS** menu to allow you to set the display brightness to between 1 and 5 for each display dimming level:

DIM HIGH (default 3), **DIM MID** (default 2), **DIM LOW** (default 1), or **DIM OFF** (default 1).

STANDBY SETTINGS

Displays the **STANDBY SETTINGS** menu to allow you to specify the standby settings.

STANDBY MODE can be set to **ECO** to reduce the standby consumption to less than 0.5W, or **NORMAL** which allows the CD35 to wake from streaming inputs.

AUTO-STANDBY automatically switches the CD35 to standby if there is no user interaction or audio from the current source for a specified delay: **AFTER 10MIN**, **AFTER 15MIN**, **AFTER 20MIN** (default), or **OFF**.

Note: The **AUTO-STANDBY** function will be disabled if the network has not been set up.

FACTORY RESET

Resets the CD35 to the factory default settings.

You are prompted to confirm. Select **YES** to proceed or **NO** to cancel.

FIRMWARE VERSIONS

Displays the **FIRMWARE VERSIONS** menu to allow you to view the versions of firmware installed.

STREAMING SETTINGS

Allows you to configure the CD35 streaming:

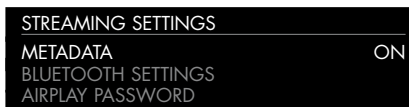

METADATA

Allows you to choose **ON** (default) or **OFF** to specify whether metadata, such as the artist name and song title, should be displayed.

BLUETOOTH SETTINGS

Displays the **BLUETOOTH SETTINGS** menu.

VISIBLE can be set to **ON** to make the CD35 visible to other Bluetooth devices, or **OFF** (default) to make the CD35 not visible.

Note: **VISIBLE** allows any Bluetooth-enabled device within range to discover and pair with your CD35.

AUTO-CONNECT can be set to **ON** to automatically reconnect to a paired mobile Bluetooth device when the Bluetooth input on the CD35 is selected, or **OFF** (default) to disable automatic connection.

AIRPLAY PASSWORD

Allows you to set an optional password for connection by AirPlay. Leave empty for no password.

NETWORK SETTINGS

Allows you to configure the network connection:



QUICK INFO

Shows the **NETWORK INFO** screen with the following information:

- Connection: one of **CONNECTED BY WIFI**, **CONNECTED BY CABLE**, or **NOT CONNECTED**.
- **NETWORK**, the current SSID.
- **IP**, the current IP address.
- **DEVICE NAME**, the device name.
- **WIFI MAC**, the Wi-Fi MAC address.
- **BT MAC**, the current Bluetooth MAC address.

You can also display this information by holding down the **i** button on the remote control.

TECHNICAL SPECIFICATION

Features

Mechanism

TEAC CD-5020-AAT

D/A Converter

1x ESS Sabre ES9028PRO

Outputs

Balanced output

4.4 VRMS, 100Ω impedance

Unbalanced output

2.2 VRMS, 370Ω impedance

Digital outputs

Coaxial: RCA

Optical: Toslink

PCM Sample Rate

44.1kHz

Performance

Frequency response:

20Hz – 20kHz: -0.3dB

Signal to noise ratio

>110 dB (AES17 filter)

THD + N: 20Hz – 20kHz <0.01%

Network

Connectivity

2 x Ethernet LAN ports

2 x Antennas for Bluetooth and Wi-Fi

LAN: 10/100Mbit Ethernet port

WLAN: IEEE 802.11 a/b/g/n/ac compliant; 2.4/5GHz;
b, g, n mode

Audio formats

WAV, LPCM, AIFF, FLAC, ALAC, WMA, OGG: Up to
192kHz/24bit

MP3, MP4 (AAC): Up to 48kHz/16bits, VBR & CBR
320kbps

DSD: Up to DSD128 (5.6MHz)

Streaming

Airplay®

Bluetooth®

Chromecast built-in®

Spotify Connect®

DLNA/UPnP

General

Control

C25 system remote control

RS232

IR in/out

Trigger in/out

Power Consumption

Standby (ECO): <0.5W

Standby (NORMAL): <6W

Operating: <25W

Dimensions

430 x 385 x 106 mm (w x d x h) with knobs and
connectors

430 x 382 x 106 mm (w x d x h) without knobs and
connectors

Weight

11 kg

Colour

Black or titanium

ADDITIONAL INFORMATION

These instructions help you get the best possible sound from your CD35.

Phase

The phase of the AC supply can make a significant difference to the sound.

Use the Polarity Pen supplied with the CD35 to verify which pin is live on your AC power cable.

Ensure that the live pin of the AC power cable is connected to the left-hand pin of the power connector, viewed from the back panel:

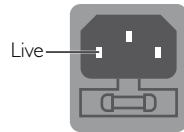

Burn-in

Your Primare will start to sound best after an initial burn-in of approximately 24 hours.

You will notice a further smaller improvement in sound quality for at least another 3 days' playing.

RS232 and trigger

The RS232 input allows you to connect the CD35 to a controller system. Use a twisted (null modem) cable. For more information contact Primare at info@primare.net or visit www.primare.net.

The Trigger output allows the CD35 to be switched on by other devices, such as an I35.

Using the CD35 with an I35

Your CD35 is an ideal companion to the Primare I35 CD Prisma Integrated Amplifier. For best results link the two products together as follows using the two cables supplied with the CD35:

To connect the trigger cable

The Trigger cable ensures that the I35 switches on, or to standby, when you operate the Φ button on the front panel of the CD35.

- Connect the Trigger cable from the CD35 TRIG OUT to the I35 TRIG IN.
- Configure the I35 to **TRIG ON**.

Factory reset

Press and hold the Φ standby button on the front panel to display the main firmware version number.

Press and hold the Φ standby button on the front panel for 10 seconds to perform a factory reset of the CD35.

You can also do a factory reset from the Prisma app, or from the **GENERAL SETTINGS** menu; see *GENERAL SETTINGS*, page 16.

Network troubleshooting

Front panel display

The front panel display indicates the type of network connection:

LAN indicates that you are connected by an Ethernet cable.

WiFi indicates that you are connected by wireless.

Network status

The **CON** indicator on the back panel indicates the network status:

ON Indicates the CD35 is connected to a network

OFF Indicates no connection to a network

Flashing indicates that the network needs to be configured using the Google Home app.

Spotify Connect

The Spotify Software is subject to third party licenses found here:

https://beta.developer.spotify.com/private-documentation/esdk-third_party_licenses

INDEX

A

- AirPlay, streaming 14
- AirPlay password (settings menus) 16
- Analogue outputs 9
- Antennae, connecting 7
- Audio settings menu 15
- Auto-dim (settings menus) 16

B

- Back panel 9
- Balance (settings menus) 15
- Balanced outputs 9
- Bluetooth, streaming 14
- Bluetooth settings (settings menus) 16

C

- Chromecast, streaming 14

D

- Digital outputs 7
- Disc
 - Ejecting 11
 - Inserting 11
 - Locating a position 11
 - Pausing 11
 - Playing 11
 - Scanning 11

E

- Ejecting a disc 11

F

- Factory reset 18
- Firmware (settings menus) 16
- Front panel (settings menus) 16
- Front panel controls 11
- Front panel display, changing 12

G

- General settings menu 16

H

- Hard disk, playing music from 13

I

- Inserting a disc 11
- IR input 9

L

- LED brightness (settings menus) 16
- Locating a position on a disc 11

M

- Maximum volume (settings menus) 15
- Menus
 - Audio settings 15
 - General settings 16
 - Network settings 16

Menus (continued)

- Playback settings 15
- Streaming settings 16
- Metadata (settings menus) 16
- Mute volume (settings menus) 15

N

- Network, connecting to 8
- Network drive, playing music from 13
- Network settings menu 16
- Network troubleshooting 18

O

- Opening the tray 11
- Output (settings menus) 15

P

- Pausing a disc 11
- Phase 18
- Playback settings menu 15
- Playing a disc 11

Q

- Quick info (settings menus) 16

R

- Remote control 10
 - Fitting batteries 10
- Repeat playback 12
- RS232 input 9, 18

S

- Scanning through a disc 11
- Specific track, playing 12
- Spotify Connect, streaming 14
- Standby settings (settings menus) 16
- Startup volume (settings menus) 15
- Streaming music 14
- Streaming settings menus 16

T

- Trigger output 9, 18

U

- Unbalanced outputs 9
- USB flash drive, playing music from 7, 13

W

- Wi-fi, connecting to 8

P R I M A R E

THE SOUND AND VISION OF SCANDINAVIA SINCE 1986

LIMSTENSGATAN 7,
216 16 LIMHAMN, SWEDEN

More information at primare.net

